

Agilent Electronic vs. Mechanical Calibration Kits: Calibration Methods and Accuracy

White Paper

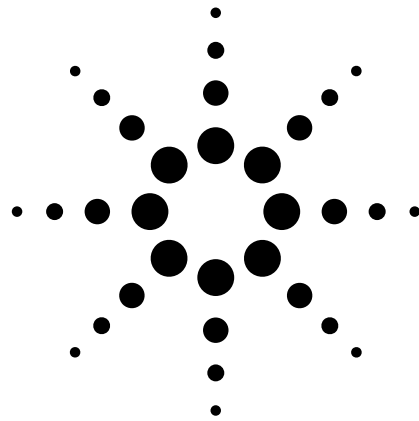

Agilent Technologies

Abstract

Traditionally, the calibration of Vector Network Analyzers (VNAs) has been accomplished with mechanical standards. This calibration process can be laborious and error prone, but is required to make accurate measurements. Electronic calibration modules have been designed to make VNA calibration faster, simpler, and easier than traditional mechanical calibration. The purpose of this paper is to clarify the differences between electronic and mechanical calibrations and how these differences affect measurement accuracy.

Introduction

VNA (Vector Network Analyzer) calibration kits require two levels of specifications, the kit level calibration standard specifications and the VNA system level calibration residual error specifications. The residual-error specifications are functions of the calibration-standard specifications, VNA system specifications and calibration methods used. A calibration kit can support many different calibration methods. Different VNAs may have different implementations of calibration methods and calibration standard definitions.

Typically, a mechanical VNA calibration kit consists of the following set of standards:

- Opens, Shorts/Offset Shorts, Loads/Sliding Loads;
- Adapters;
- Precision offsets – waveguide or coaxial.

Calibration methods that these calibration kits can support include [1]:

- Short/Open Load/Thru (SOLT)
- Short/Offset Short/Load/Offset Load/Thru
- Thru/Reflect/Line or Thru/Reflect/Match (TRL/TRM).

Electronic calibration (ECal) kits consist of at least one module that can electronically connect various impedance states to the VNA's test port [2]. The characteristics of these impedance states are stored in EEPROM (Electrically Erasable Programmable Read-Only Memory) that can be read by the VNA or a PC controller to perform a calibration. Different modules cover different frequency ranges. The calibration method used is similar to the open/short/load/through method or the offset shorts/through method. The Agilent PNA Series of network analyzers can also support unknown through and external ideal through calibrations using an ECal module. Most ECal modules use four impedance states to compute the VNA's systematic error terms to reduce calibration errors. Some recent broadband models, such as the 10 MHz to 67 GHz model, use seven impedance states to improve calibration accuracy. Figure 1 shows a simplified block diagram of an electronic calibration device with four reflective impedance states and two through states.

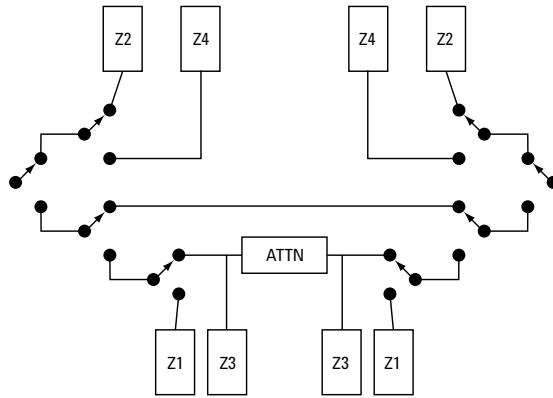

Figure 1. Simplified schematic diagram of a two-port electronic calibration device.

Mechanical Calibration Kits

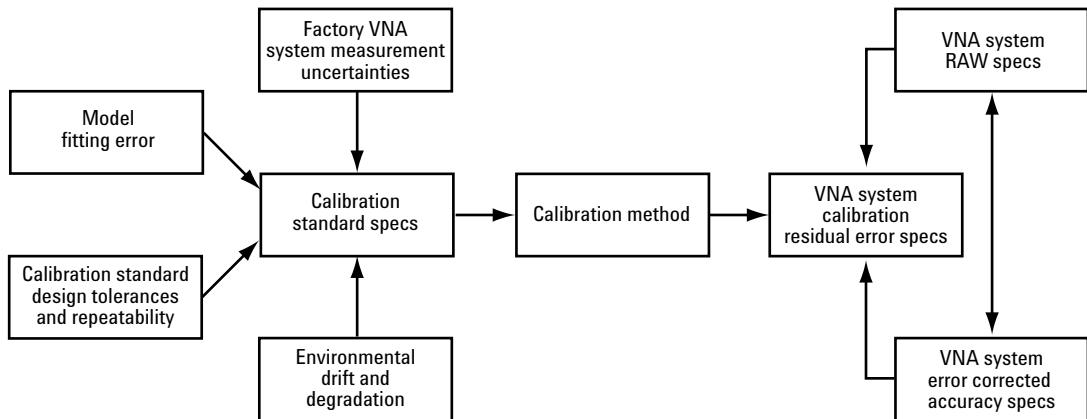

Figure 2. Mechanical calibration system standard specs and VNA system spec relationships.

Calibration standard specifications

Figure 2 shows the key factors that influence the calibration standard specifications. Different calibration standards have different key characteristics that are important for the calibration method used. The male and female shorts, for example, must be matched in electrical characteristics in order to minimize errors in TRL/TRM calibrations; but this is not critical for SOLT calibrations. On the other hand, the opens and shorts should be as close to being 180 degrees out of phase as possible over the entire applicable frequency range to minimize calibration errors using the SOLT calibration method.

Traditionally, electrical characteristics of opens and shorts are described by the calibration coefficients of the devices. Most VNAs use the following parameters to calculate the calibration standard's response:

Offset Delay, Offset Loss, Offset Zo, Min. Freq, Max Freq, Coax or WG, and
C0, C1, C2, C3 terms for opens,
L0, L1, L2, L3 terms for shorts
Fixed or sliding for loads

These parameters are also known as "Calibration Coefficients" of the calibration standards.¹ Other Agilent Technologies VNA products use similar implementations of these calibration coefficients. Actual device deviation from this defined electrical characteristic determines the accuracy of the calibration. Specifications of calibration devices are, therefore, defined as deviations from the calibration coefficient responses.

Recently, Agilent's PNA Series network analyzers have started using "data-based models" [2]. The data-based models reduce the errors caused by fitting of data to the calibration coefficients. Specifications of calibration devices are defined as deviations from the "nominal" data-based response plus data interpolation errors.

Sources of errors

Opens and shorts

Typically, the magnitude response of opens and shorts is very consistent. Their phase response, however, has more significant variations from device to device. The maximum phase deviation allowed from the nominal response, as defined by the calibration coefficients or data file, provides the necessary margin to warrant VNA residual source match and reflection tracking specifications. Dimensional variation is the main cause of device characteristic deviations. For very broadband requirements, the calibration coefficient model error has more impact. The data based model is much more accurate.

Fixed loads

Usually, the calibration coefficients define fixed loads as perfect system impedance terminations with zero reflection. The offset terms may be used to create an imperfect load that matches the actual reflection of the device. The actual reflection coefficient or return loss of fixed loads is the primary error. If the actual data is used, then the uncertainty of the actual data becomes the primary error.

Arbitrary impedance

Loads may be defined as arbitrary impedance standards. By using offset terms, in conjunction with a user defined terminating impedance (a real number for most network analyzers, a complex number for the PNA), a more accurate model of the load may be possible. Again, the deviation of the actual device response from the assumed calibration coefficient model is the major source of calibration error.

Sliding loads

Sliding loads have an effective return loss specification. It has the same meaning as the return loss specification of the fixed load. It cannot be measured directly, but is calculated from a set of measurements taken with the sliding load element set at various positions.

Airlines (air dielectric transmission lines)

Airlines are used in TRL/LRL calibrations. They can be used as offset devices to do offset short and offset load calibrations. Since they are mechanically simple, they can be fabricated with very tight tolerances and therefore are highly desirable as primary calibration devices. The main source of error is dimensional variation.

1. Agilent Technologies Product Note 8510-5B, *Specifying Calibration Standards for the Agilent 8510 Network Analyzer*, describes how these calibration coefficients relates to the frequency response of the calibration standards.

Calibration residual errors

Calibration residual errors depend on the calibration method used. The traditional method is SOLT. Three independent equations are generated from the measurement of three distinct calibration standards, open/short/load. The one-port error coefficients, directivity, source match, and reflection tracking, are determined. The transmission tracking and load match terms are then determined using the through measurements. Appendix A provides the theoretical derivation of the relationship between calibration standard errors and calibration residual errors for this calibration method.

The same detail error analysis for the TRL/LRL calibration method has not been attempted. An estimate is provided by reference [3]

TRL residual errors:

$$\delta = -W ; \quad \tau = 1 - W^2 ; \quad \mu = W$$

$$W = \frac{Z_0 - Z_c}{Z_0 + Z_c} \text{ where } Z_0 \equiv \text{system impedance, } Z_c \equiv \text{impedance of line/thru}$$

Equation 1.

Other publications [4][5] have applied the covariance matrix method to determine the TRL calibration errors.

Recently, the PNA has incorporated the weighted least squares method in the computation of VNA error coefficients using mechanical calibration standards. Appendix B shows the error propagation of calibration standards through the covariance matrix using the least squares approach.

ECal Calibration Kits

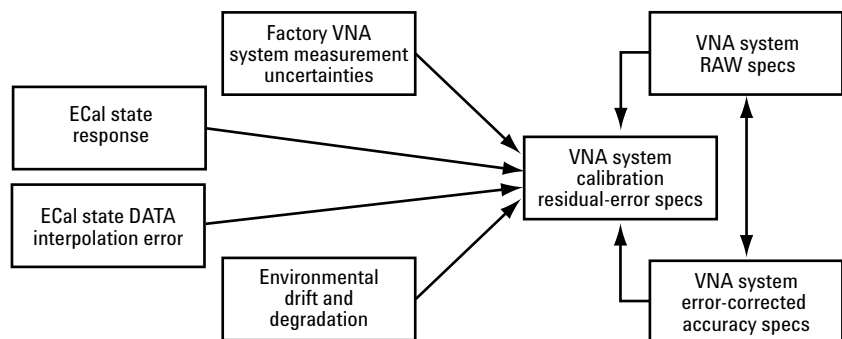

Figure 3. ECal module specs in relationship to VNA system specs.

ECal impedance state specifications

ECal impedance states are transfer impedance standards. The errors of their characterization are transferred to the residual errors of VNA calibration. The actual impedance of the impedance state is, therefore, less critical than their mechanical cal kit's equivalent. The actual values of the impedance states, however, do have some impact on the sensitivity of the characterization errors. To be consistent with the mechanical cal kit specifications, it is desirable to put a max and min limit on each of the impedance states. It is the deviation from the stored EEPROM data that contributes to the calibration residual errors, NOT the specifications of each the impedance states.

ECal residual errors

Sources of errors

The total impedance-state error budget includes the following factors:

- Characterization uncertainty
- State stability
- Drift with respect to time and operating temperature
- Environmental changes
- Aging
- Interpolation error

Characterization uncertainties are usually dominated by systematic errors. Aging phenomena is not random. These two factors are additive to the random errors – state stability, drift, and environmental changes. The random errors are RSS. Total ECal's state error is:

$$\mathcal{E}_x = \mathcal{E}_{(\text{meas unc})} + \mathcal{E}_{(\text{aging})} + \mathcal{E}_{(\text{interpolation})} + \sqrt{\mathcal{E}_{(\text{stability})}^2 + \mathcal{E}_{(\text{drift})}^2 + \mathcal{E}_{(\text{env})}^2}$$

Equation 2.

One-port residuals

ECal uses a minimum of four impedance states in conjunction with the least squares fit method to compute the systematic errors of the VNA. The standard residual error equations for 1-port calibration using three known standards do not apply. Instead, the covariance matrix from the least squares fit solution is used to determine the residual errors. The system equations are weighted by the total uncertainty of each impedance state. The weighting factors, $e_1, e_2, e_3, \dots, e_n$, are derived from the sources of errors for each impedance state. Since this is a least squares fitted solution, the uncertainty terms do not propagate through to the residual calibration-error terms algebraically like the mechanical calibration kits. Appendix B shows how the errors of each impedance state propagate through to the calibration residual errors.

Two-port residuals

ECal's two-port residual computation uses the same method as the mechanical cal kit when the through is not an ideal through. Because the insertion loss of the ECal through can be as high as 7 dB, the transmission tracking and load-match errors are higher than the mechanical cal kits. If an ideal thru is used, now available as an ECal calibration option, the transmission residual errors can be better than or equal to those of the mechanical calibration kits.

Calibration Results Compared

The following graphs, in Figures 4 through 8, show the vector magnitude differences of the VNA systematic-error coefficients between the reference calibration performed using mechanical standards and the calibration performed using an ECal module characterized based on the reference calibration. It is evident from these graphs that the differences are within the connector repeatability error of the 1.85 mm connector. Thus, calibrations performed with ECal are as accurate as the original calibration used to characterize the ECal module.

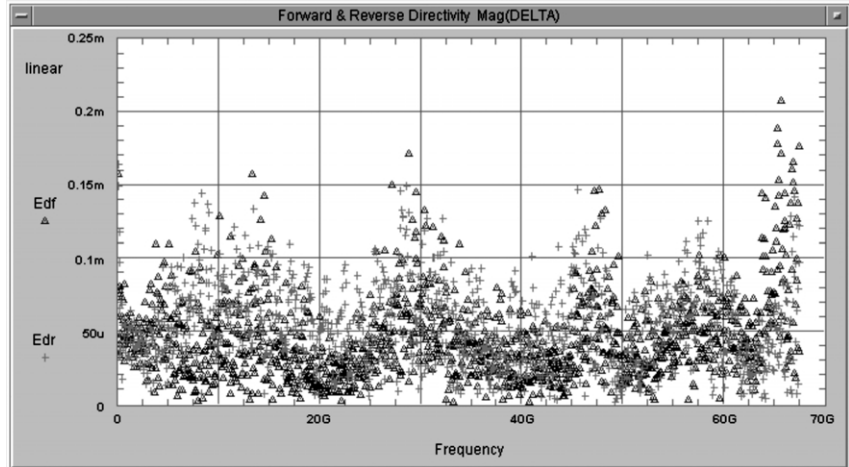

Figure 4. Magnitude of [Raw Directivity (ref) – Raw Directivity (ECal)].

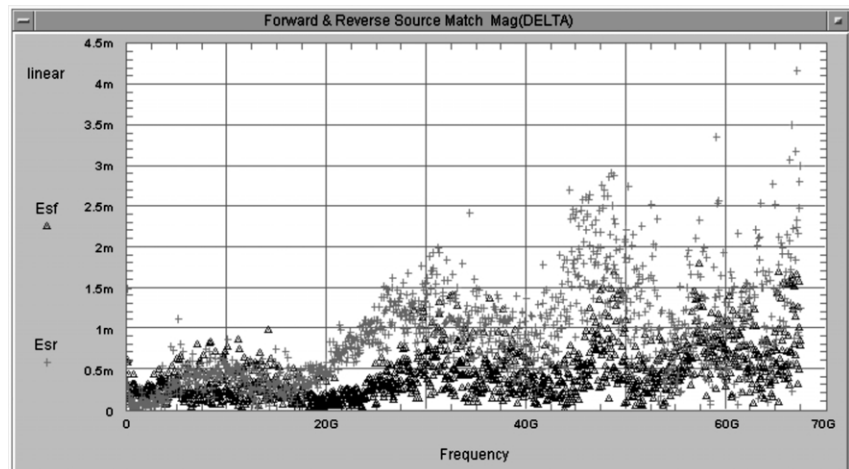

Figure 5. Magnitude of [Raw Source Match (ref) – Raw Source Match (ECal)].

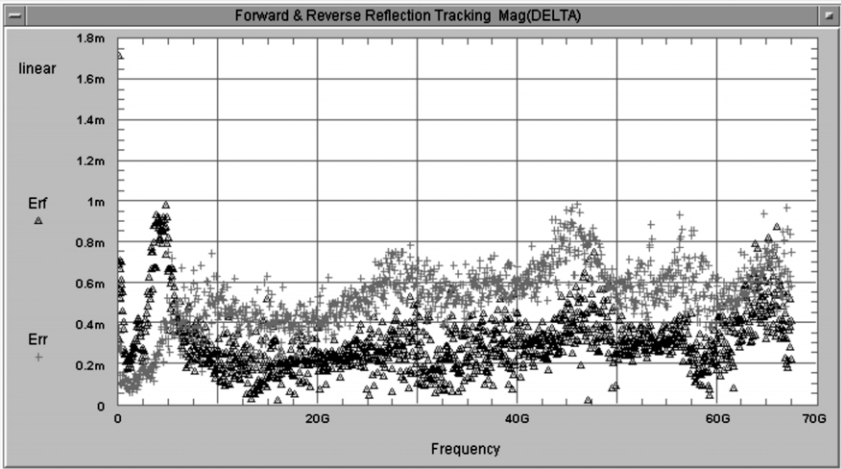

Figure 6. Magnitude of [Raw Load Match (ref) - Raw Load Match (Ecal)].

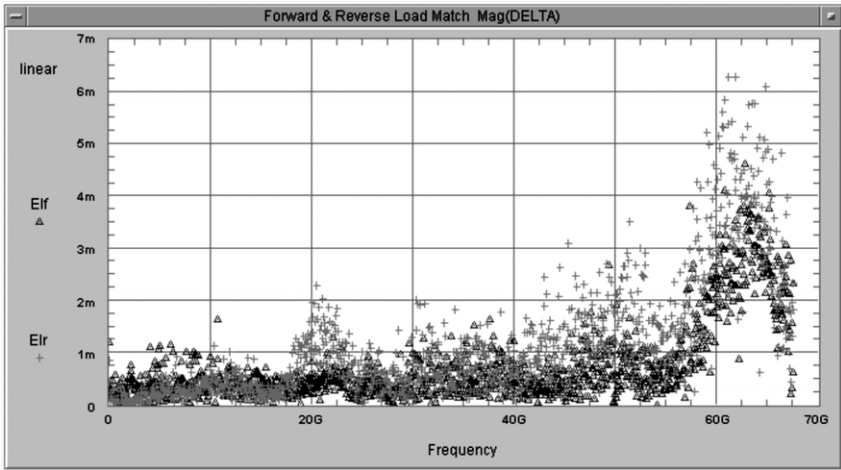

Figure 7. Magnitude of [Raw Reflection Tracking (ref) - Raw Reflection Tracking (Ecal)].

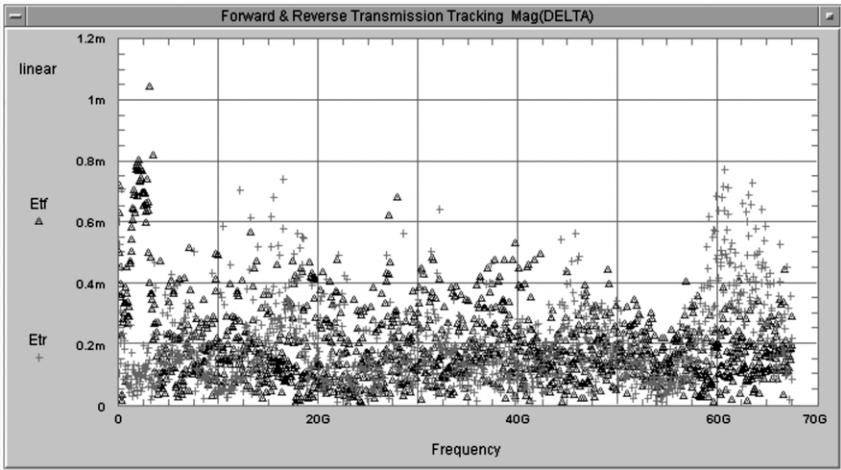
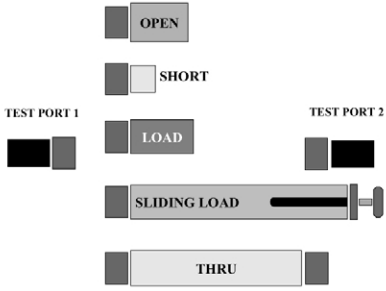
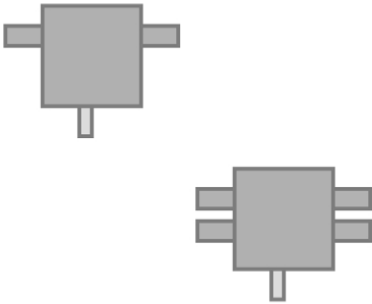

Figure 8. Magnitude of [Raw Transmission Tracking (ref) - Raw Transmission Tracking (Ecal)].

Quick Compare: Mechanical vs. ECal

	Mechanical	ECal
Physical appearance		
Number of connections for		
1-port calibration	≥ 3	≥ 1
2-port calibration	≥ 5 (TRL), 7 (SOLT)	≥ 2
4-port calibration	≥ 18 (SOLT)	≥ 4
Response defined by	Calibration coefficients	Measured data
Response errors defined by	Deviation from cal coefficient model	Measurement uncertainty
Error correction computation	Algebraic - # equations = # unknowns	Least square fit – over determined
Residual cal errors computation	Sensitivity functions	Covariance matrix
Directivity	\sim reflection of load	$\sim \sigma_{E2} \leq$ mechanical
Source match	\sim residual (directivity + refltn tracking)	$\sim \sigma_{E3} \leq$ mechanical
Reflection tracking	\sim average of open and short errors	$\sim (\sigma_{E1} + \sigma_{E2}E_2 + \sigma_{E3}E_3) \leq$ mechanical
Load match	\sim residual directivity if ideal through	\sim residual directivity + S_{11} unc of thru (\geq mechanical using internal through) (\leq mechanical using external through)
Transmission tracking	Function of raw and residual load match and source match	$\sim S_{21}$ unc/ S_{21} + other terms (\geq mechanical using internal through) (\leq mechanical using external through)

Conclusion

ECal calibration operates quite differently from traditional mechanical vector network analyzer calibration. ECal offers flexibility in non-insertable calibrations that can be difficult for mechanical calibration. Its one-port calibration accuracy depends on the accuracy of the ECal's impedance state measurement process. For two-port and multipoint calibrations, the residual errors related to the transmission terms can be improved and made equal to mechanical calibrations if an external ideal through is used (or low-loss through) instead of the internal through. ECal offers added ease-of-use with fewer connections (especially for multipoint calibration) over mechanical calibration. Fewer connections, greatly reduces connection errors as well as wear on connectors. In summary, the speed and consistency of ECal calibration cannot be matched by mechanical calibration.

Appendix A: Calibration Kit Calibration Residual Errors – Algebraic Solution

One-port residuals [6], [7]

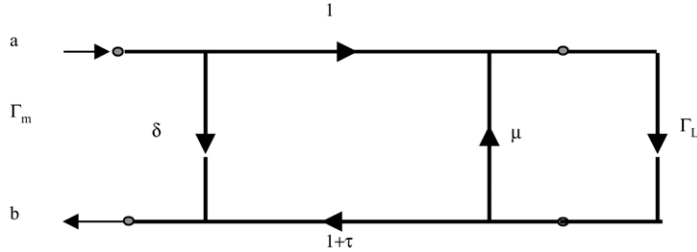

Figure 9. One-port residual error model.

Let: $\delta \equiv$ residual directivity
 $\mu \equiv$ residual source match
 $\tau \equiv$ residual reflection tracking

and: $\Gamma_1 \equiv$ actual response of cal standard 1
 $\Gamma_2 \equiv$ actual response of cal standard 2
 $\Gamma_3 \equiv$ actual response of cal standard 3

$\Delta\Gamma_1 \equiv$ error of cal standard 1
 $\Delta\Gamma_2 \equiv$ error of cal standard 2
 $\Delta\Gamma_3 \equiv$ error of cal standard 3

then:

$$\delta = -(D_1\Gamma_2\Gamma_3 + D_2\Gamma_1\Gamma_3 + D_3\Gamma_1\Gamma_2)$$

$$\tau = D_1(\Gamma_2 + \Gamma_3) + D_2(\Gamma_1 + \Gamma_3) + D_3(\Gamma_1 + \Gamma_2)$$

$$\mu = -(D_1 + D_2 + D_3) / (1 + \tau)$$

Equation 3.

where :

$$D_1 = \frac{\Delta\Gamma_1}{(\Gamma_1 - \Gamma_2)(\Gamma_1 - \Gamma_3)}; \quad D_2 = \frac{\Delta\Gamma_2}{(\Gamma_2 - \Gamma_3)(\Gamma_2 - \Gamma_1)}; \quad D_3 = \frac{\Delta\Gamma_3}{(\Gamma_3 - \Gamma_1)(\Gamma_3 - \Gamma_2)}$$

Equation 4.

Two-port residuals

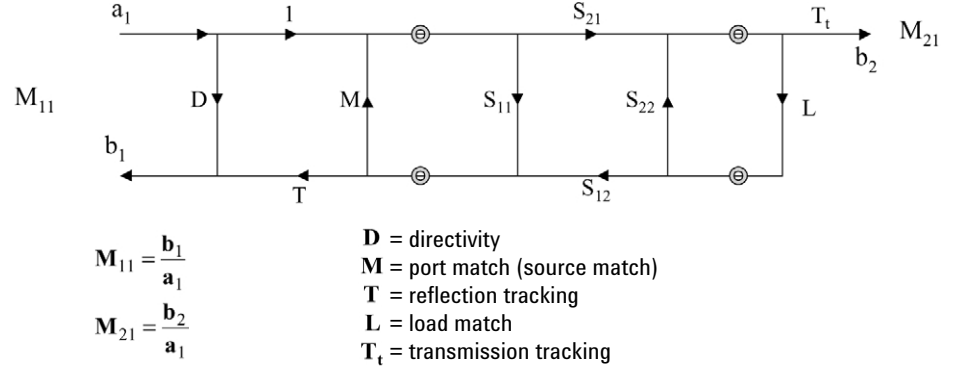

Figure 10. Signal flow graph of transmission calibration terms.

Transmission tracking and load-match residual errors depend on the performance specifications of the cables and test sets used just as much as the calibration kit's performance specifications. These terms are calculated from the specifications of the cal kit, test-port cables, adapters and the S-parameter test set used. The following is provided as a reference on how these terms can be derived. As a general case, a non-ideal through is used to connect port 1 to port 2 during the transmission calibration.

To determine the residual load-match error of a VNA using a finite length non-ideal through with known S_{11} , S_{21} , S_{12} , S_{22} and their errors e_{11} , e_{21} , e_{12} , e_{22} . Assume that $S_{21}=S_{12}$:

$$M_{11} = D + \frac{T[S_{11}(1 - S_{22}L) + S_{21}S_{12}L]}{1 - S_{11}M - MS_{21}S_{12}L - S_{22}L} \Rightarrow L = \frac{TS_{11} + (D - M_{11})(1 - S_{11}M)}{T(S_{11}S_{22} - S_{21}S_{12}) + (D - M_{11})(MS_{21}S_{12} + S_{22})}$$

Equation 5.

By taking the partial derivative of L with respect to all the dependent variables and ignoring second and higher order terms, we get:

$$\frac{\partial L}{\partial S_{11}} = \frac{1}{S_{21}S_{12}}; \quad \frac{\partial L}{\partial S_{21}} = TS_{12}L; \quad \frac{\partial L}{\partial S_{22}} = TS_{21}S_{12}L^2$$

$$\frac{\partial L}{\partial D} = \frac{1}{TS_{21}S_{12}}; \quad \frac{\partial L}{\partial M} = S_{21}S_{12}L^2; \quad \frac{\partial L}{\partial T} = \frac{S_{11} + S_{21}S_{12}L}{TS_{21}S_{12}}$$

Equation 6.

Let λ =load-match error d =directivity error, t =reflection-tracking error, m =port match error, e_{11} , e_{21} and e_{22} are errors of S_{11} , S_{21} and S_{22} respectively.

The upper bound of load-match error is the sum of all the partial derivative terms.

$$\lambda = \left(\frac{1}{S_{21}S_{12}} \right) \left[e_{11} + \frac{d + t(S_{11} + S_{21}S_{12}L)}{T} \right] + S_{21}S_{12}L^2 (m + e_{22}T) + e_{21}TS_{12}L$$

Equation 7.

It is evident from Equation 7, $\lambda \approx d$ if the through is an ideal through, $S_{11}=S_{22}=0$, and $S_{21}=S_{12}=1$. [Note that the error terms in Equation 7 are not the same as the residual error-model terms as defined in Figure 7. See Appendix B for the proper transformation.]

To determine the residual transmission tracking error of a VNA using a finite length non-ideal thru with known S_{11} , S_{21} , S_{12} and S_{22} and $S_{21}=S_{12}$:

$$M_{21} = \frac{T_t S_{21}}{1 - S_{11}M - MS_{21}S_{12}L - S_{22}L} \Rightarrow T_t = \frac{M_{21}(1 - S_{11}M - MS_{21}S_{12}L - S_{22}L)}{S_{21}}$$

Equation 8.

Again, taking the partial derivative of the T_t with respect to all the dependent variables we get:

$$\begin{aligned} \frac{\partial T_t}{\partial S_{11}} &= \frac{-T_t M}{1 - S_{11}M - MS_{21}S_{12}L - S_{22}L}; & \frac{\partial T_t}{\partial S_{12}} &= \frac{T_t S_{21}ML}{1 - S_{11}M - MS_{21}S_{12}L - S_{22}L}; \\ \frac{\partial T_t}{\partial S_{21}} &= \frac{-T_t(1 - S_{11}M - S_{22}L)}{1 - S_{11}M - MS_{21}S_{12}L - S_{22}L}; & \frac{\partial T_t}{\partial S_{11}} &= \frac{-T_t L}{1 - S_{11}M - MS_{21}S_{12}L - S_{22}L}; \\ \frac{\partial T_t}{\partial M} &= \frac{-T_t(S_{11} + S_{21}S_{12}L)}{1 - S_{11}M - MS_{21}S_{12}L - S_{22}L}; & \frac{\partial T_t}{\partial L} &= \frac{-T_t(MS_{21}S_{12} + S_{22})}{1 - S_{11}M - MS_{21}S_{12}L - S_{22}L}; \end{aligned}$$

Equation 9.

Let t =transmission tracking error, m =source match error, l =load match error, e_{11} , e_{21} , e_{12} and e_{22} are errors of S_{11} , S_{21} , S_{12} , and S_{22} respectively. The upper bound transmission tracking error, ignoring the second and higher order terms is:

$$\tau = T_t \left[e_{11}M + \frac{e_{21}}{S_{21}} + e_{12}S_{21}ML + e_{22}L + m(S_{11} + S_{21}S_{12}L) + \lambda(MS_{21}S_{12} + S_{22}) \right]$$

Equation 10.

If the thru is ideal, $S_{11}=S_{22}=0$ & $S_{21}=S_{12}=1$, then the above equation reduces to:

$$\tau = \lambda M + mL$$

Equation 11.

Appendix B: Calibration Kit Calibration Residual Errors – Least Squares Solution

One-port residuals

ECal uses at least four impedance states in conjunction with the least squares fit method to compute the systematic errors of the VNA. The standard residual error equations for one-port calibration using three known standards do not apply. Instead, the covariance matrix from the least squares fit solution is used to determine the residual errors. The systems equations are weighted by the total uncertainty of each impedance state. The weighting factors, $e_1, e_2, e_3, \dots, e_n$, are derived from the sources of errors for each impedance state. Since this is a least squares fitted solution, the uncertainty terms do not propagate through to the residual calibration error terms algebraically like the mechanical calibration kits.

$$\begin{bmatrix} \frac{\Gamma_1}{\mathcal{E}_1} & \frac{1}{\mathcal{E}_1} & \frac{-\Gamma_1 \Gamma_{m1}}{\mathcal{E}_1} \\ \frac{\Gamma_2}{\mathcal{E}_2} & \frac{1}{\mathcal{E}_2} & \frac{-\Gamma_2 \Gamma_{m2}}{\mathcal{E}_2} \\ \frac{\Gamma_3}{\mathcal{E}_3} & \frac{1}{\mathcal{E}_3} & \frac{-\Gamma_3 \Gamma_{m3}}{\mathcal{E}_3} \\ \downarrow & \downarrow & \downarrow \\ \frac{\Gamma_n}{\mathcal{E}_n} & \frac{1}{\mathcal{E}_n} & \frac{-\Gamma_n \Gamma_{mn}}{\mathcal{E}_n} \end{bmatrix} \begin{bmatrix} E_1 \\ E_2 \\ E_3 \\ \vdots \\ E_n \end{bmatrix} = \begin{bmatrix} \frac{\Gamma_{m1}}{\mathcal{E}_1} \\ \frac{\Gamma_{m2}}{\mathcal{E}_2} \\ \frac{\Gamma_{m3}}{\mathcal{E}_3} \\ \vdots \\ \frac{\Gamma_{mn}}{\mathcal{E}_n} \end{bmatrix}$$

Equation 12.

$$[\text{cov}(E)] = \begin{bmatrix} \sigma_{E1}^2 & \sigma_{E1E2}^2 & \sigma_{E1E3}^2 \\ \sigma_{E2E1}^2 & \sigma_{E2}^2 & \sigma_{E2E3}^2 \\ \sigma_{E3E1}^2 & \sigma_{E3E2}^2 & \sigma_{E3}^2 \end{bmatrix}$$

Equation 13.

The covariance of the [E] terms are not the same as the residual model terms. They must be converted to the residual-error model equivalent:
From the residual-error model:

$$\Gamma_m = \Gamma + \Delta\Gamma = \delta + \frac{(1 + \tau)\Gamma}{1 - \mu\Gamma};$$

$$\Delta\Gamma = \delta + \frac{\tau\Gamma + \mu\Gamma^2}{1 - \mu\Gamma} \approx \mu\Gamma^2 + \tau\Gamma + \delta$$

Equation 14.

Since $\Gamma E_1 + E_2 - \Gamma\Gamma_m E_3 = \Gamma_m$, solving for Γ

Equation 15.

The sensitivity function of Γ with respect to E_1 , E_2 , and E_3 are:

$$\frac{\partial \Gamma}{\partial E_1} = \frac{\Gamma(\Gamma E_3 + 1)}{E_2 E_3 - E_1}, \quad \frac{\partial \Gamma}{\partial E_2} = \frac{\Gamma E_3 + 1}{E_2 E_3 - E_1}, \quad \frac{\partial \Gamma}{\partial E_3} = \frac{\Gamma(\Gamma E_1 + E_2)}{E_1 - E_2 E_3}$$

Equation 16.

Let

$$[\Delta E] = \begin{bmatrix} \frac{\partial \Gamma}{\partial E_1} & \frac{\partial \Gamma}{\partial E_2} & \frac{\partial \Gamma}{\partial E_3} \end{bmatrix}$$

Equation 17.

$$\sigma_{\Gamma}^2 = [\Delta E][Cov(E)][\Delta E^*]^T$$

Equation 18.

The measurement uncertainty of Γ can be determined from equation(18). To express this uncertainty in terms of the error model, additional expansion is required.

The upper bound uncertainty of Γ is equal to the sum of the diagonal terms:

$$\begin{aligned} |\Delta \Gamma| &= \left| \sigma_{E_1} \left| \frac{\partial \Gamma}{\partial E_1} \right| + \sigma_{E_2} \left| \frac{\partial \Gamma}{\partial E_2} \right| + \sigma_{E_3} \left| \frac{\partial \Gamma}{\partial E_3} \right| \right| \\ &= \left(\frac{|\sigma_{E_1}| |E_3| + |\sigma_{E_3}| |E_1|}{|E_1 - E_2 E_3|} \right) |\Gamma^2| + \left(\frac{|\sigma_{E_1}| + |\sigma_{E_2}| |E_3| + |\sigma_{E_3}| |E_2|}{|E_1 - E_2 E_3|} \right) |\Gamma| + \frac{|\sigma_{E_2}|}{|E_1 - E_2 E_3|} \end{aligned}$$

$\sigma_{E_1}, \sigma_{E_2}, \sigma_{E_3}$ are the square root of the diagonal elements of $[Cov(E)]$

Equation 19.

Equating equation 18 to equation 16, we obtain:

$$|\delta| = \frac{|\sigma_{E_2}|}{|E_1 - E_2 E_3|}, \quad |\tau| = \frac{|\sigma_{E_1}| + |\sigma_{E_2}| |E_3| + |\sigma_{E_3}| |E_2|}{|E_1 - E_2 E_3|}, \quad |\mu| = \frac{|\sigma_{E_3}|}{|E_1 - E_2 E_3|}$$

Equation 20.

Interesting Reading

- A. Ferrero, U. Pisani, *Two-Port Network Analyzer Calibration Using an Unknown 'Thru'*, IEEE Microwave and Guided Wave Letters, Vol. 2, No. 12, pp 505-507, Dec. 1992
- A. Ferrero, U. Pisani, F. Sanpietro, *Save the "Thru" in the ANA Calibration*, 40th ARFTG Conference Digest, PP 128-135, Dec., 1992
- H. Eul, B. Schick, *A Generalized Theory and New Calibration Procedures for Network Analyzer Self-Calibration*, IEEE Transaction on MTT, Vol. 39, No. 4, pp 724-731, April 1991
- G. Madonna, A. Ferrero, U. Pisani, *A Simple NWSA Calibration Algorithm Based on a Transfer Standard*, IEEE Instrumentation and Measurement Technology Conferences, May 19-21, 1997
- J.A. Jargon, R.B. Marks, *Two-Tier Multiline TRL for Calibration of Low-Cost Network Analyzers*, 46th ARFTG Conference Digest, pp 1-8, Dec. 1995.
- J.A. Jargon, R.B. Marks, D.K. Rytting, *Robust SOLT and Alternative Calibrations for Four-Sampler Vector Network Analyzers*, IEEE Transactions on MT&T, Vol. 47, No. 10, pp. 2008-2013, Oct. 1999

References

- [1] R.B. Marks, *Formulations of the Basic Vector Network Analyzer Error Model Including Switch Terms*, 50th ARFTG Conference Digest, pp 115,126, Dec. 1997.
- [2] D. Blackham, *Application of Weighted Least Squares to OSL Vector Error Correction*, to be published 61st ARFTG Conference, June 13th, 2003.
- [3] D. Rytting, *Network Accuracy Overview*, 58th ARFTG Conference Digest, Technical Session 2, Fall 2001.
- [4] H. VanHamme, V. Vanden Bossche, *Flexible Vector Network Analyzer Calibration With Accuracy Bonds Using an 8-Term or a 16-Term Error Correction Mode*, IEEE Transactions on Microwave Theory and Techniques, Vol. 42, No. 6, pp. 976-987, June 1994.
- [5] R. B. Marks, *A Multiline Method of Network Analyzer Calibration*, IEEE Trans. Microwave Theory and Tech., vol. 39, No. 7, pp. 1205-1215 July 1991.
- [6] B. Bianco, A. Corana, S. Ridella, C. Simicich, *Evaluation of Errors in Calibration Procedures for Measurements of Reflection Coefficient*, IEEE Transaction on Instrumentation and Measurement, Vol. IM-27, No. 4, pp 354-358, Dec. 1978.
- [7] R.D. Pollard, *Verification of System Specifications of a High Performance Network Analyzer*, 23rd ARFTG Conference Digest, pp 38-46, Spring 1984.

Web Resources

For more information about Agilent electronic calibration (ECal) modules visit:
www.agilent.com/find/ecal

For more information about Agilent PNA Series network analyzers visit:
www.agilent.com/find/pna



Agilent Email Updates

www.agilent.com/find/emailupdates

Get the latest information on the products and applications you select.

Agilent T&M Software and Connectivity

Agilent's Test and Measurement software and connectivity products, solutions and developer network allows you to take time out of connecting your instruments to your computer with tools based on PC standards, so you can focus on your tasks, not on your connections. Visit

www.agilent.com/find/connectivity
for more information.

Online Assistance:

www.agilent.com/find/assist

Product specifications and descriptions in this document subject to change without notice

Copyright © 2003 Agilent Technologies
Printed in U.S.A. June 9, 2003
5988-9477EN



Agilent Technologies